

Beta

— EASY —



2023

**Promoción válida a partir
del 1 de Febrero del 2023.
Precios IVA no incluido.**

www.beta-tools.es

Beta
— EASY —

GAMA 2023

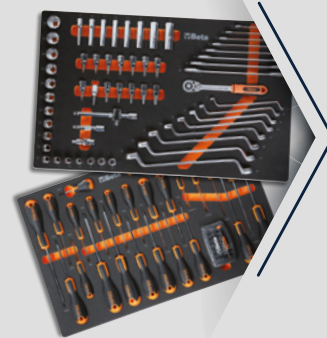

1/4

860EA/31

008600992



Juego de 30 puntas para atornillar con portapuntas magnético, en estuche de plástico

31x



	861LP	●	0,5x3-0,6x4,5-0,8x5,5-1,0x5,5-1,2x6,5-1,6x8 mm
	861PH	⊕	PH1-PH2-PH3
	861PZ	⊕	PZ1-PZ-PZ3
	861PE	○	2-3-4-5-6-8 mm
	861TX	⊙	T8-T9-T10-T15-T20-T25-T27-T30-T40
	861PQ	○	1-2-3 mm
	882M1	○ 1/4 - ● 1/4	



4 mm

1256/C21-1

012560122



Juego de 21 puntas para atornillar con portapuntas magnético, en estuche de plástico

21x



	1256LP	●	1,5-2-2,5 mm
	1256PH	⊕	PH0-PH1
	1256PZ	⊕	PZ0-PZ1
	1256PE	○	0,7-0,9-1,3-1,5-2-2,5-3 mm
	1256TX	⊙	T4-T5-T6-T7
	1256RTX	⊕	T8-T10-T15
		4 mm	99 mm



14"

903E/C42

009031042

Surtido de 13 llaves de vaso hexagonales, 18 puntas para atornillar, 4 llaves macho hexagonales acodadas y 7 accesorios, en maletín de plástico

42x



	C900	○	4-4,5-5-5,5-6-7-8-9-10-11-12-13-14 mm
	900E/55	⊕	
	C900/25		
	C900/20		50 mm
	C900/20L		100 mm
	C900/42		115 mm
	C900/30		150 mm
	96	○	1,3-1,5-2-2,5 mm
	C900AD	⊕	14
	861LP	●	10 0,6x4-0,8x5,5-1,2x6,5 mm
	861PH	⊕	10 PH1-PH2-PH3
	861PZ	⊕	10 PZ1-PZ2-PZ3
	861PE	○	10 3-4-5-6 mm
	861TX	⊙	10 T10-T15-T20-T25-T30

190x160x60 mm

3/8"

913E/C33

009131033

Surtido de 28 llaves de vaso hexagonales y 5 accesorios, en maletín de plástico



285x210x84 mm

	C910A	○	6-7-8-9-10-11-12-13-14-15-16-17-18-19-20-21-22-24 mm
	C910AL	○	8-9-10-12-13-14-17-19 mm
	C956E	○	16 mm (5/8") 21 mm (13/16")
	910E/55	⊗	
	C910/25		
	C910/21		75 mm
	C910/22		150 mm
	C920/15F	□	1/2" - 3/8"

12"

923E/C25

009231025

Surtido de 20 llaves de vaso hexagonales y 5 accesorios, en maletín de plástico



285x210x84 mm

	C920A	○	8-9-10-11-12-13-14-15-16-17-18-19-20-21-22-23-24-27-30-32 mm
	920E/55	⊗	
	C920/25		
	C920/21		125 mm
	C920/22		250 mm
	C910/16F	□	3/8" - 1/2"



12"



923E-PE/C18

009231028



Surtido de 18 llaves de vaso hexagonales y 5 accesorios, en maletín de plástico



 55 mm	C920PE	○	4-5-6-7-8-10-12-14-17-19 mm
 100 mm	C920PE-L	○	4-5-6-7-8 mm
 140 mm	C920PE-XL	○	10-12-14 mm

285x210x84 mm

12"



923E-TX/C18

009231018



Surtido de 18 llaves de vaso macho para tornillos con perfil Torx®, en maletín de plástico



 55 mm	C920TX	⊗	T20-T25-T27-T30-T40-T45-T50-T55-T60-T70
 100 mm	C920TX-L	⊗	T20-T25-T27-T30-T40
 140 mm	C920TX-XL	⊗	T45-T50-T55

285x210x84 mm

12"



923E-FTX/C17

009231017



Surtido de 17 vasos de mano para tornillos con perfil Torx®, en maletín de plástico



	C920FTX	⊗	E10-E12-E14-E16-E18-E20-E22-E24
	C920TX	⊗	T20-T25-T27-T30-T40-T45-T50-T55-T60

285x210x84 mm

3/4"

928E/C17

009282017

Surtido de 12 llaves de vaso hexagonales y 5 accesorios, en maletín de plástico



	C928A	⊙	22-24-27-30-32-34-36-38-41-46-50-55 mm
	C928/55	⊙	
	C928/25		
	C928/21		100 mm
	C928/22		200 mm
	C928/42		455 mm

555x370x92 mm



1/4" 1/2"

903E/C98

009031098

Surtido de 45 llaves de vaso hexagonales, 35 puntas para atornillar, 4 llaves macho hexagonales acodadas y 14 accesorios, en maletín de plástico



1/4"		C900	⊙	4-4,5-5-5,5-6-7-8-9-10-11-12-13-14 mm
		C900L	⊙	6-7-8-9-10-11-12-13 mm
		900E/55	⊙	
		C900/25		
		C900/20		50 mm
		C900/20L		100 mm
		C900/30		150 mm
		C900/42		115 mm

1/2"		C920A	⊙	10-11-12-13-14-15-16-17-18-19-20-21-22-24-27-30-32 mm
		C920L	⊙	14-15-17-19-22 mm
		C956C	⊙	16 mm (5/8") - 21 mm (13/16")
		920E/55	⊙	
		C920/25		
		C920/21		125 mm
		C920/22		250 mm

375x295x84 mm



	C910/16F		□ 3/8" - ■ 1/2"
	C895/6		□ 1/2" - ◊ 5/16"
	C900AD	⊙	14"
	892/0	●	1/4" - ■ 1/4"

	861PH	⊕	⊙ PH1-PH2
	861PZ	⊕	⊙ PZ1-PZ2
	861PE	⊙	⊙ 3-4-5-6 mm
	861LP	●	⊙ 0,6x4-0,8x5,5-1,2x6,5 mm
	861TX	⊙	⊙ T10-T15-T20-T25-T27-T30
	C866LP	●	⊙ 1,6x8-1,6x10-2,0x12 mm
	C866PH	⊕	⊙ PH3-PH4
	C866PZ	⊕	⊙ PZ3-PZ4
	866PE	⊙	⊙ 7-8-10-12-14 mm
	866TX	⊙	⊙ T40-T45-T50-T55-T60-T70
	96	⊙	⊙ 1,3-1,5-2-2,5 mm

1/4" 3/8" 1/2"

903E/C170

009031170

Surtido de 74 llaves de vaso hexagonales, 42 puntas para atornillar, 30 llaves de vaso, 7 llaves macho hexagonales acodadas y 17 accesorios, en maletín de plástico



453x375x90 mm

1/4"

	C900	○	4-4,5-5-5,5-6-7-8-9-10-11-12-13-14 mm
	C900L	○	4-5-6-7-8-9-10 mm
	900E/55	⊗	
	C900/25		
	C900/20		50 mm
	C900/20L		100 mm
	C900/30		150 mm
	C900/42		115 mm
	C900FTX	⊗	E4-E5-E6-E7-E8
	C900LP	●	0,8x4-1,0x5,5-1,2x6,5-1,2x8 mm
	C900PH	⊕	PH0-PH1-PH2
	C900PZ	⊕	PZ0-PZ1-PZ2
	C900ME	○	3-4-5-6 mm
	C900TX	⊗	T08-T09-T10-T15-T20-T25-T27-T30
	C900RTX	⊗	T08-T09-T10-T15-T20-T25-T27-T30

3/8"

	C910A	○	10-11-12-13-14-15-16-17-18-19 mm
	C910AL	○	10-11-12-13-14-15 mm
	C910FTX	⊗	E10-E11-E12-E14-E16
	C956E	○	18 mm (11/16")
	910E/55	⊗	
	C910/25		
	C910/22		150 mm

1/2"

	C920A	○	10-11-12-13-14-15-16-17-18-19-20-21-22-24-27-30-32 mm
	C920L	○	16-17-18-19-22 mm
	C920FTX	⊗	E18-E20-E24
	C956C	○	16 mm (5/8") - 21 mm (13/16")
	920E/55	⊗	
	C920/25		
	C920/21		125 mm
	C920/22		250 mm
	C910/16F		□ 3/8" - ■ 1/2"

	96	○	0,9-1,5-2-2,5-3-4-5 mm
	C895/4		□ 3/8" - ○ 5/16"
	C895/6		□ 1/2" - ○ 5/16"
	C900AD		⊗ - ⊗
	892/0		⊗ - ⊗
	861RTX	⊕	⊗ T09-T10-T15-T20-T25-T27-T30-T40
	861TX	⊗	⊗ T6-T7-T8
	861RIBE	⊗	⊗ 7-8-9 mm
	861XZN	○	⊗ 5-6-8 mm
	C866LP	●	⊗ 1,6x8-1,6x10-2,0x12 mm
	C866PH	⊕	⊗ PH3-PH4
	C866PZ	⊕	⊗ PZ3-PZ4
	866PE	○	⊗ 7-8-10-12-14 mm
	866TX	⊗	⊗ T40-T45-T50-T55-T60-T70
	866RTX	⊗	⊗ T40-T45-T50-T55-T60-T70



14" 12"

2046E/C116

020460116

Maleta porta-herramientas con surtido de 116 herramientas para el mantenimiento general, de plástico



453x375x90 mm

1/4"

	C900	○	4-4,5-5-5,5-6-7-8-9-10-11-12-13-14 mm
	C900L	○	6-7-8-9-10-11-12-13 mm
	900E/55	⊕	
	C900/25		
	C900/20		50 mm
	C900/20L		100 mm
	C900/30		150 mm
	C900/42		115 mm

12"

	C920A	○	10-11-12-13-14-15-16-17-18-19-20-21-22-24-27-30-32 mm
	C920L	○	14-15-17-19-22 mm
	C956C	○	16 mm (5/8") - 21 mm (13/16")
	920E/55	⊕	
	C920/25		
	C920/21		125 mm
	C920/22		250 mm
	C910/16F	□	3/8" - 1/2"
	C895/6F	□	1/2" - 5/16"

	C900AD	⊕	1/4"
	892/0		● 1/4" - ■ 1/4"
	861PH	⊕	⊕ PH1-PH2
	861PZ	⊕	⊕ PZ1-PZ2
	861PE	○	⊕ 3-4-5-6 mm
	861LP	●	⊕ 0,6x4-0,8x5,5-1,2x6,5 mm
	861TX	⊕	⊕ T10-T15-T20-T25-T27-T30
	C866LP	●	⊕ 1,6x8-1,6x10-2,0x12 mm
	C866PH	⊕	⊕ PH3-PH4
	C866PZ	⊕	⊕ PZ3- PZ4
	866PE	○	⊕ 7-8-10-12-14 mm
	866TX	⊕	⊕ T40-T45-T50-T55-T60-T70
	42C	⊕	7-8-9-10-11-12-13-14-15-16-17-18-19 mm
	96/SC9	○	1,5-2-2,5-3-4-5-6-8-10 mm



14" 12"

2047E/C108
020470008

Maleta porta-herramientas con surtido de 108 herramientas para el mantenimiento general, de plástico



555x370x92 mm

1/4"

	C900	○	4-4,5-5-5,5-6-7-8-9-10-11-12-13-14 mm
	900E/55	⊕	
	C900/25		
	C900/20		50 mm
	C900/20L		100 mm
	C900/30		150 mm
	C900/42		115 mm

860EA/31

	861LP	0,5x3-0,6x4-5,0,8x5,5-1,0x5,5-1,2x6,5-1,6x8 mm
	861PH	1-2-3
	861PZ	1-2-3
	861PE	2-3-4-5-6-8 mm
	861TX	T8-T9-T10-T15-T20-T25-T27-T30-T40
	861PQ	1-2-3 mm
	882M1	○ 1/4 - ● 1/4



12"

	C920A	○	10-11-12-13-14-15-16-17-18-19-20-21-22-24-27-30-32 mm
	C956C	○	16 mm (5/8") - 21 mm (13/16")
	920E/55	⊕	
	C920/25		
	C920/21		125 mm
	C920/22		250 mm
	C910/16F		□ 3/8" - ■ 1/2"

	C900AD	⊕ 14"	
	42C	⊕	7-8-9-10-11-12-13-14-15-16-17-18-19 mm
	96/SC9	○	1,5-2-2,5-3-4-5-6-8-10 mm
	1048		250 mm
	1082CM	⌒	160 mm
	1150CM	≡	180 mm
	1166CM	●	160 mm
	1201E	●	3x75-4x100-5,5x125-6,5x150mm
	1202E	⊕	PH1-PH2
	1370C		300 g



1/4"

2054E-100

020540001

Maleta porta-herramientas con surtido de 100 herramientas para el mantenimiento general

- Termoformado de espuma incluido



400x300x140 mm



x100

	42C		6-7-8-9-10-11-12-13-14-15-16-17-19 mm
	96K/SP9		1,5-2-2,5-3-4-5-6-8-10 mm
	1048C		250 mm
	1082CM		160 mm
	1150CM		180 mm
	1166CM		160 mm
	1201E		3x75-5,5x100-6,5x150 mm
	1202E		PH0x60-PH1x80-PH2x100 mm
	1253		3,5x100 mm
	1370C		300 g
	1692/3		3 m
	1770A		9 mm
	1770RL		10x
	1777BM		190 mm
	1725CR		150 mm

860EA/31

	861LP	0,5x3-0,6x4,5-0,8x5,5-1,0x5,5-1,2x6,5-1,6x8 mm
	861PH	1-2-3
	861PZ	1-2-3
	861PE	2-3-4-5-6-8 mm
	861TX	T8-T9-T10-T15-T20-T25-T27-T30-T40
	861PQ	1-2-3 mm
	882M1	○ 1/4 - ● 1/4



1/4"

	882P/80	○ 1/4 - ● 1/4
	895 /1	○ 1/4 - □ 1/4
	C900	○ 4-4,5-5-5,5-6-7-8-9-10-11-12-13-14 mm
	C900/20	50 mm
	C900/20L	100 mm
	C900/25	
	C900/30	150 mm
	C900/42	115 mm
	C900/48	⊗ 150 mm

 **1/4" 3/8"** **2054E-128**
 020540002

Maleta porta-herramientas con surtido de 128 herramientas para el mantenimiento general















- Termoformado de espuma incluido

x 128















400x300x140 mm

860EA/31





















		861LP	0,5x3-0,6x4,5- 0,8x5,5-1,0x5,5- 1,2x6,5-1,6x8 mm
		861PH	1-2-3
		861PZ	1-2-3
		861PE	2-3-4-5-6-8 mm
		861TX	T8-T9-T10-T15-T20- T25-T27-T30-T40
		861PQ	1-2-3 mm
		882M1	1/4 - 1/4



1256/C21-1

	1256LP		1,5-2-2,5 mm
	1256PH		PH0-PH1
	1256PZ		PZ0-PZ1
	1256PE		0,7-0,9-1,3-1,5-2-2,5-3 mm
	1256TX		T4-T5-T6-T7
	1256RTX		T8-T10-T15
		4 mm	99 mm











	42C		7-8-9-10-11-12-13-14-15-16- 17-19 mm
	96K/SP9		1,5-2-2,5-3-4-5-6-8-10 mm
	1048C		250 mm
	1082CM		160 mm
	1150CM		180 mm
	1166CM		160 mm
	1201E		3x75-5,5x100-6,5x150 mm
	1202E		PH0x60-PH1x80-PH2x100 mm
	1128BMXC		150 mm
	1370C		300 g
	1692/3		3 m
	1771	3x	18 mm
	1771RL		10x
	1833XS/2		133 mm Pilas: 2xAAA (no incluidas)

1/4"

	895 /1		1/4 - 1/4
	C900		4-4,5-5-5,5-6-7-8-9-10- 11-12-13 mm
	C900/20L		100 mm
	C900/25		
	C900/30		150 mm
	C900/42		115 mm
	C900/48		150 mm

3/8"

	C910A		14-15-17-18-19-22-24 mm
	C910/22		150 mm
	C910/25		
	C910/72		200 mm
	C920/15F		1/2" - 3/8"



14" 12"

2056E

020560010

Maleta porta-herramientas con surtido de 163 herramientas para el mantenimiento general

- Panel de herramientas interno extraíble
- Termoformado de espuma incluido



465x330x170 mm

x 163



Maleta + 163 herramientas

861/C61

●	861LP	0,5x3 (2)-0,5x4(2)-0,6x4,5(2)-0,8x5(2)-1,0x5,5(2)-1,0x6(2)-1,6x8(2) mm
+	861PH	PH0(2)-PH1(7)-PH2(7)-PH3(2)
+	861PZ	PZ0(2)-PZ1(3)-PZ2(3)-PZ3(2)
○	861PE	1,5-2-2,5-3-4-4,5-5-5,5-6-8 mm
○	861TX	T9-T10-T15-T20-T25 T27-T30-T40
		○ 1/4 - ● 1/4



1256/C21-1

	1256LP	●	1,5-2-2,5 mm
	1256PH	+	PH0-PH1
	1256PZ	+	PZ0-PZ1
	1256PE	○	0,7-0,9-1,3-1,5-2-2,5-3 mm
	1256TX	○	T4-T5-T6-T7
	1256RTX	⊗	T8-T10-T15
		4 mm	99 mm



	42C	⊗	8-9-10-11-12-13-14-15-16-17-18-19 mm
	96BPC/SK9	○	1,5-2-2,5-3-4-5-6-8-10 mm
	111		250 mm
	1048C		250 mm
	1082CM	⚡	160 mm
	1150CM	≡	180 mm
	1166CM	●	160 mm
	1201E	●	2,5x50-3x75-4x125-5,5x150-6,5x150-8x150 mm
	1202E	+	PH1x80-PH2x100 mm
	1209E/PZ	+	PZ1x80-PZ2x100 mm
	1128BMXC		150 mm
	1253	●	3,5x100 mm
	1370C		300 g
	1692/5		5 m
	1725CR		150 mm
	1771	3x	18 mm

Trolley + 163 herramientas



1/4" 1/2"

2056T/E
020560110

Trolley porta-herramientas con surtido de 163 herramientas para el mantenimiento general

- Mango telescópico ajustable
- Panel de herramientas interno extraíble
- Termoformado de espuma incluido

1/4"

	895 /1	Ⓜ 14"
	C900	○ 4-4,5-5-5,5-6-7-8-9-10-11-12-13-14 mm
	C900/20	50 mm
	C900/20L	100 mm
	C900/25	
	C900/30	150 mm
	C900/42	115 mm
	C900/48	Ⓜ 150 mm

1/2"

	C920A	○ 10-11-12-13-14-15-16-17-18-19-21-22-24 mm
	C920/21	125 mm
	C920/22	250 mm
	C910/16F	□ 3/8" - ■ 1/2"
	C920/25	
	C920/72	Ⓜ 260 mm

x
163



465x330x225mm



12"

2120L-E/T91

021200911

Caja de herramientas de chapa con surtido de 91 herramientas para el mantenimiento general

- Termoformados rígidos incluidos



550x200x210 mm

12"



C920A	○	10-11-12-13-14-15-16-17-18-19-20-21-22-23-24-27-30-32 mm	20
C920/72	⊗	250 mm	
C920/25			



C920/21	○	125 mm	5
C920/22		250 mm	
C910/16F	□ 3/8" - ■ 1/2"		
1048C		250 mm	
1771	3x	18 mm	



42C	⊗	8-9-10-11-12-13-14-15-16-17-19 mm	20
96K/SP9	○	1,5-2-2,5-3-4-5-6-8-10 mm	



1202E	●	2,5x50-3x75-4x100-5,5x125-6,5x150 mm	6
1202EN	●	4x30 mm	



860EA/31	⊕ ⊖ ⊕ ⊕ ⊕ ⊕ ⊕ ⊕		37
C900AD	⊕ 14"		
C900/30		150 mm	
1202E	⊕	PH0x60-PH1x80-PH2x100 mm	
1202EN	⊕	PH1x30 mm	



1082CM	⌞	160 mm	3
1150CM	≡	180 mm	
1166CM	●	160 mm	

C22E

022000130

Caja de herramientas con 3 cajones

- 3 cajones de 435x210x50 mm, montados sobre guías telescópicas de rodamientos
- Compartimento superior de 505x256x60 mm
- Cerradura centralizada frontal
- Asa en la tapa
- Tiradores laterales retráctiles para facilitar el transporte

kg 20

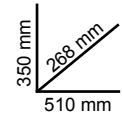

n°	h	max
3	50 mm	5 kg



14" 12"

2200E/21

022002201

Caja de herramientas con 3 cajones con surtido de 159 herramientas

- Termoformados de espuma incluidos

	1048C	250 mm
	1128BMXC	150 mm
	1370C	300 g
	1692/5	5 m



22

42C 8-10-11-12-13-14-15-17-19 mm
1082CM 160 mm
1150CM 180 mm
1770A 9 mm
1770RL 10x



715

861/C61
1256/C21-1
4 mm

1256/C21-1
4 mm

14" C900/48 150 mm
C900/25 115 mm
C900/42 115 mm
C900AD
C900 4-4,5-5-5,5-6-7-8-9-10-11-12-13-14 mm
C900/20 50 mm
C900/20L 100 mm

12" C920/72 260 mm
C920/25 250 mm
C920/22 250 mm
C910/16F 3/8" - 1/2"
C920A 13-14-15-16-17-18-19-21-22 mm



18

96BPC/SK9 1,5-2-2,5-3-4-5-6-8-10 mm
1201E 2,5x50-3x75-4x100-5,5x125 mm
1201EN 4x30
1202E PH1x80-PH2x100
1202EN PH1X30 mm
1253 3,5x100 mm



C43

043000003

Trolley porta-herramientas de 3 módulos

- Estructura en chapa y material plástico
- 3 módulos separables:
 - 1 cesta superior (altura 222 mm)
 - 1 módulo central (altura 168 mm), con 2 cajones (altura 60 mm)
 - 1 módulo inferior (altura 332 mm), con puerta basculante (altura 280 mm), con ruedas
- Ruedas de \varnothing 128 mm
- Mango telescópico ajustable en 4 posiciones
- Sistema de desenganche de los módulos con acceso fácil a todos los compartimentos de herramientas
- Cesta superior con bandeja porta-objetos interno extraíble y 2 porta-piezas pequeñas integrados en la tapa



827 mm
323 mm
526 mm

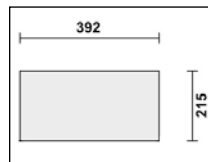



4300E/21

043002201

Trolley porta-herramientas con surtido de 212 herramientas para el mantenimiento general

	42C		7-8-9-10-11-12-13-14-15-16-17-18-19-22 mm
	96BPC/SK9		1,5-2-2,5-3-4-5-6-8-10 mm
	111		200 mm
	1048C		250 mm
	1052C		240 mm
	1082CM		160 mm
	1150CM		180 mm
	1166CM		160 mm
	1201E		2,5x50-3x75-4x100-5,5x150-6,5x150 mm
	1201EN		4x30 mm
	1202E		PH0x60-PH1x80-PH2x100 mm
	1202EN		PH1x30 mm
	1128BMXC		150 mm
	1253		3,5x100 mm
	1370C		300 g
	1390C		Ø 35 mm
	1692/3		3 m
	1695XS		70 mm
	1771		3x 18 mm
	1771RL		10x
	1725CR		150 mm
	1098C		220 mm
	1719C P		200 mm
	1719C M		200 mm
	1719C R		200 mm
	1833XS/2		133 mm Pilas: 2xAAA (no incluidas)

861/C61

	861LP	0,5x3 (2)-0,5x4(2)-0,6x4,5(2)-0,8x5(2)-1,0x5,5(2)-1,0x6(2)-1,6x8(2) mm
	861PH	PH0(2)-PH1(7)-PH2(7)-PH3(2)
	861PZ	PZ0(2)-PZ1(3)-PZ2(3)-PZ3(2)
	861PE	1,5-2-2,5-3-4-4,5-5-5,5-6-8 mm
	861TX	T9-T10-T15-T20-T25 T27-T30-T40
		Ø 1/4 - 1/4



1256/C21-1

	1256LP		1,5-2-2,5 mm
	1256PH		PH0-PH1
	1256PZ		PZ0-PZ1
	1256PE		0,7-0,9-1,3-1,5-2-2,5-3 mm
	1256TX		T4-T5-T6-T7
	1256RTX		T8-T10-T15
			4 mm 99 mm



903E/C42 14"

	C900		4-4,5-5-5,5-6-7-8-9-10-11-12-13-14 mm
	C900E/55		
	C900/25		
	C900/20		50 mm
	C900/20L		100 mm
	C900/42		115 mm
	C900/30		150 mm
	96		1,3-1,5-2-2,5 mm
	C900AD		14"
	861LP		Ø 0,6x4-0,8x5,5-1,2x6,5 mm
	861PH		PH1-PH2-PH3
	861PZ		PZ1-PZ2-PZ3
	861PE		3-4-5-6 mm
	861TX		T10-T15-T20-T25-T30



923E/C25 12"

	C920A		8-9-10-11-12-13-14-15-16-17-18-19-20-21-22-23-24-27-30-32 mm
	C920E/55		
	C920/25		
	C920/21		125 mm
	C920/22		250 mm
	C910/16F		□ 3/8" - 1/2"





C04BOX

024002021



Cajonera móvil con 6 cajones

- 6 cajones de 570x410 mm, montados sobre guías telescópicas de rodamientos:
 - 1 cajón altura 80 mm
 - 4 cajones altura 110 mm
 - 1 cajón altura 160 mm
- El fondo de los cajones está protegido por tapetes de goma expandida
- 4 ruedas de Ø 125 mm: 2 fijas y 2 giratorias (2 con freno)
- Cerradura de seguridad centralizada frontal
- Encimera de polipropileno

6 cajones

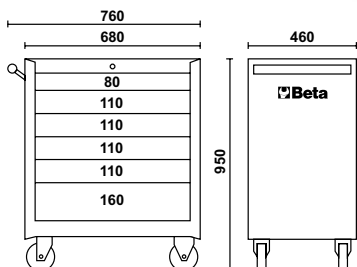
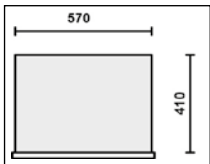

n°	h	max
1	80 mm	20 kg
4	110 mm	20 kg
1	160 mm	25 kg

CO4BOX VUES
024002203

Cajonera móvil con 6 cajones con surtido de 196 herramientas para el mantenimiento general, en termoformados de espuma

- 6 cajones de 570x410 mm, montados sobre guías telescópicas de rodamientos:
 - 1 cajón altura 80 mm
 - 4 cajones altura 110 mm
 - 1 cajón altura 160 mm
- El fondo de los cajones está protegido por tapetes de goma expandida
- 4 ruedas de Ø 125 mm: 2 fijas y 2 giratorias (2 con freno)
- Cerradura de seguridad centralizada frontal
- Encimera de polipropileno



36

42C	6-7-8-9-10-11-12-13-14-15-16-17-19-21-22-24 mm	1202EN	PH1x30 mm
96BPC/SK9	1,5-2-2,5-3-4-5-6-8-10 mm	1128BMXC	145 mm
1201E	3,5x100-5,5x150-6,5x150 mm	1719C P	200 mm
1202E	PH1x80-PH2x100 mm	1719C M	200 mm
1201EN	4x30 mm	1719C R	200 mm

23

31C	Ø 2-3-4-5-6 mm	1370C	300 g
1048C	250 mm	1390C	Ø 35 mm
1082CM	160 mm	1692	3 m
1150CM	180 mm	1771	18 mm
1166CM	160 mm	1771RL	10x

137

14 C900

○ 4-4,5-5-5,5-6-7-8-9-10-11-12-13-14 mm
○ 6-7-8-9-10-11-12-13 mm

C900L	12-13-14-15-16-17-18-19-20-21-22-24-27-30-32 mm
C900AD	14-15-17-19 mm
C900/20	50 mm
C900/20L	100 mm
C900/25	150 mm
C900/30	150 mm
C900/42	150 mm
C900/48	150 mm

12 C910/16F □ 3/8" - 1/2"

C920A	12-13-14-15-16-17-18-19-20-21-22-24-27-30-32 mm
C920L	14-15-17-19 mm
C920/21	125 mm
C920/22	250 mm
C920/25	260 mm
C920/72	16 mm (5/8") - 21 mm (13/16")
C956C	16 mm (5/8") - 21 mm (13/16")

861/C61

●	861LP	0,5x3 (2)-0,5x4(2)-0,6x4,5(2)-0,8x5(2)-1,0x5,5(2)-1,0x6(2)-1,6x8(2) mm
+	861PH	PH0(2)-PH1(7)-PH2(7)-PH3(2)
+	861PZ	PZ0(2)-PZ1(3)-PZ2(3)-PZ3(2)
○	861PE	1,5-2-2,5-3-4-4,5-5-5,5-6-8 mm
⊗	861TX	T9-T10-T15-T20-T25 T27-T30-T40
		○ 1/4 - ● 1/4

1256/C21-1

	1256LP	●	1,5-2-2,5 mm
	1256PH	⊕	PH0-PH1
	1256PZ	⊕	PZ0-PZ1
	1256PE	○	0,7-0,9-1,3-1,5-2-2,5-3 mm
	1256TX	○	T4-T5-T6-T7
	1256RTX	⊗	T8-T10-T15
			4 mm 99 mm



C24EH/7 0

024002042

Cajonera móvil con 7 cajones

- 7 cajones de 588x367 mm, montados sobre guías telescópicas de rodamientos:
 - 5 cajones altura 70 mm
 - 1 cajón altura 140 mm
 - 1 cajón altura 210 mm
- 4 ruedas de Ø 125 mm: 2 fijas y 2 giratorias (2 con freno)
- Cerradura de seguridad centralizada frontal
- Encimera en ABS de alta resistencia con 3 bandejas para piezas pequeñas
- Capacidad de carga estática: 700 kg



7 cajones

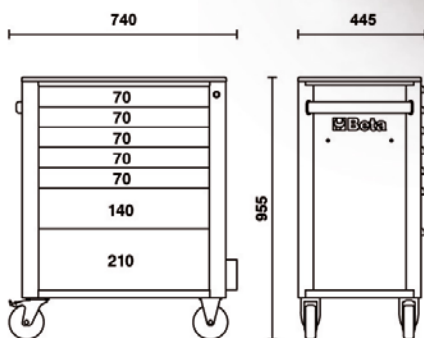
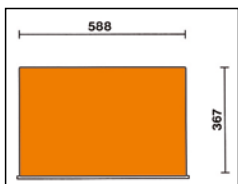

n°	h	↓ max
5	70 mm	25 kg
1	140 mm	30 kg
1	210 mm	30 kg



2400EH/IBERIA2

024002030

Cajonera móvil con 7 cajones con surtido de 240 herramientas para el mantenimiento general, en termoformados de espuma

- 7 cajones de 588x367 mm, montados sobre guías telescópicas de rodamientos:
 - 5 cajones altura 70 mm
 - 1 cajón altura 140 mm
 - 1 cajón altura 210 mm
- El fondo de los cajones está protegido por tapetes de goma expandida
- 4 ruedas de Ø 125 mm: 2 fijas y 2 giratorias (2 con freno)
- Cerradura de seguridad centralizada frontal
- Encimera en ABS de alta resistencia con 3 bandejas para piezas pequeñas
- Capacidad de carga estática: 700 kg



36

42C
 6-7-8-9-10-11-12-13-14-15-16-17-18-19-20-21-22-23-24 mm

55C
 6x7-8x9-10x11-12x13-14x15-16x17-18x19-20x22 mm

90C
 6x7-8x9-10x11-12x13-14x15-16x17-18x19-20x22 mm

111
 250 mm

159

14"

C900 ○ 4-4,5-5-5,5-6-7-8-9-10-11-12-13-14 mm
C900L ○ 4-4,5-5-5,5-6-7-8-9-10-11-12-13-14 mm
C900/48 ⊕ 150 mm **C900/20** 50 mm
C900/25 115 mm **C900/20L** 100 mm
C900/42 115 mm **C900/30** 150 mm
C900ME ○ 3-4-5-6-7-8 mm
C900TX ⊙ T06-T07-T08-T09-T10-T15-T20-T25
C900AD ⊕ - ⊖

32

1201E
 ● 2,5x50-3x75-4x100-5,5x125-6,5x150-8x200 mm

1201EN
 ● 4x30 mm

1202E
 ⊕ PH0x60-PH1x80-PH2x100-PH3x150 mm

1202EN
 ⊕ PH1x30 mm

1207E/TX
 ⊙ T06-T07-T08-T09-T10-T15-T20-T25-T27-T30-T40

96BPC/SK9
 ○ 1,5-2-2,5-3-4-5-6-8-10 mm

- 12"**
- C920A** ○ 8-9-10-11-12-13-14-15-16-17-18-19-20-21-22-23-24-27-30-32 mm
C920L ○ 10-12-13-14-15-16-17-18-19-21-22 mm
C920/72 ⊕ 260 mm **C920/21** 125 mm
C920/25 **C920/22** 250 mm
C910/16F □ 3/8" - ■ 1/2"
C920PE ○ 5-6-7-8-9-10-12-14 mm
C920TX ⊙ T27-T30-T40-T45-T50-T55-T60

13

1082CM † 160 mm
1150CM † 180 mm
1166CM ● 200 mm
1032-180 ○ 19+60 mm
1034-170 ○ 19+60 mm
1036-175 ● 19+60 mm
1038-175 ● 19+60 mm
1048C 250 mm
1370C ⊕ 500 g
1390C Ø 35 mm
32C Ø 4 mm
34C 150 mm
36C 130 mm

861/C61

●	861LP	0,5x3 (2)-0,5x4(2)-0,6x4,5(2)-0,8x5(2)-1,0x5,5(2)-1,0x8(2)-1,6x8(2) mm
⊕	861PH	PH0(2)-PH1(7)-PH2(7)-PH3(2)
⊕	861PZ	PZ0(2)-PZ1(3)-PZ2(3)-PZ3(2)
○	861PE	1,5-2-2,5-3-4-4,5-5-5,5-6-8 mm
⊙	861TX	T9-T10-T15-T20-T25 T27-T30-T40
□		○ 1/4 - ● 1/4





5945E/2021

059450301

Surtido de 271 herramientas para el mantenimiento general, en termoformados de espuma



para **C45PRO**

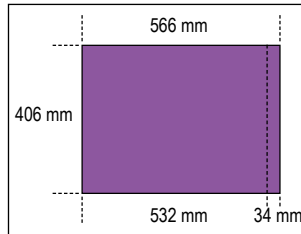

30

42C 6-7-8-9-10-11-12-13-14-15-16-17-18-19-20-21-22-24-27-30-32 mm
96BPC/SK9 1,5-2-2,5-3-4-5-6-8-10 mm

36

1082CM 160 mm
1150CM 180 mm
1166CM 160 mm
1032-180 19+60 mm
1034-170 19+60 mm
1036-175 19+60 mm
1038-175 19+60 mm
1048C 250 mm
1052C 240 mm
97TTXC T10-T15-T20-T25-T30
1256/C21-1 4 mm

18

96TC 2-2,5-3-4-5-6-7-8 mm
1370C 300 g
1390C 35 mm
34C 150-175-200 mm
1719C Q 200 mm
1719C T 200 mm
1719C P 200 mm
1719C M 200 mm
1719C R 200 mm

25

1201E 2,5x50-3x75-4x100-5,5x125-6,5x150-8x200 mm
1201EN 4x30 mm
1202E PH0x60-PH1x80-PH2x100-PH3x150 mm
1202EN PH1x30 mm
1207E/TX T06-T07-T08-T09-T10-T15-T20-T25-T27-T30-T40-T45
1253 3,5x100 mm

162

895/1 C900 1/4" - 1/4"
 4-4,5-5-5,5-6-7-8-9-10-11-12-13-14 mm
C900L 5-6-7-8-9-10-11-12-13 mm
C900ME 3-4-5-6-7 mm
C900LP 0,8x4-1x5,5-1,2x6,5-1,2x8 mm
C900PH PH1-PH2-PH3-PH4
C900TX T10-T15-T20-T25-T27-T30
C900/20 50 mm
C900/20L 100 mm
C900/25
C900/30 150 mm
C900/42 115 mm
C900/48 150 mm
C956E 16-18-21 mm
861/C61

12

895/6 C920A 5/16" - 1/2"
 8-10-11-12-13-14-15-16-17-18-19-20-21-22-23-24-26-27-28-30-32 mm
C920/25
C920/21 125 mm
C920/22 250 mm
C910/16F 3/8" - 1/2"
C920/72 260 mm
895/3 CC910A 1/4" - 3/8"
 6-7-8-9-10-11-12-13-14-15-16-17-18-19-20-21-22 mm
C920/15F 1/2" - 3/8"
C910/21 75 mm
C910/22 150 mm
C910/25
C910/72 205 mm

Beta

— EASY —

¡Todo
al alcance
de la mano!



Las imágenes que se reproducen son indicativas. Beta Utensili S.p.A. se reserva el derecho de realizar actualizaciones y mejoras en su gama de productos, sin previo aviso.

Beta

Ganando juntos

Fabio Quartararo

2022 MotoGP

World Championship



Partnership 2022



BETA IBERIA S.L.

Avda. de Castilla, 26 – Nave 4 · 28830 San Fernando de Henares · MADRID

Tel.: 91 677 83 40 · Email: beta.iberia@beta-tools.com

www.beta-tools.es